

















SOT-23 Plastic-Encapsulate D IcXYg

BZX84C2V4-BZX84C43  

FEATURES

-    
- 300mW  ab
-     43V 
-     ab

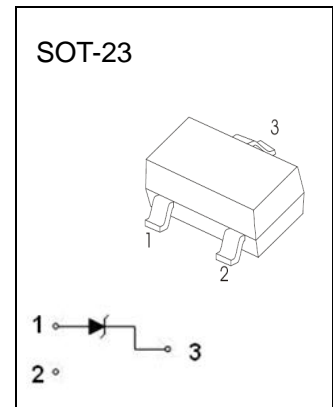

Maximum Ratings (T_a=25°C unless otherwise specified)

Characteristic	Symbol	Value	Unit
Forward Voltage (V _F) @ I _F = 10mA	V _F	0.9	V
Power Dissipation (P _d)	P _d	300	mW
Thermal Resistance from Junction to Ambient (R _{JA})	R _{JA}	417	°C/W
Junction Temperature (T _j)	T _j	150	°C
Storage Temperature (T _{stg})	T _{stg}	-55~150	°C

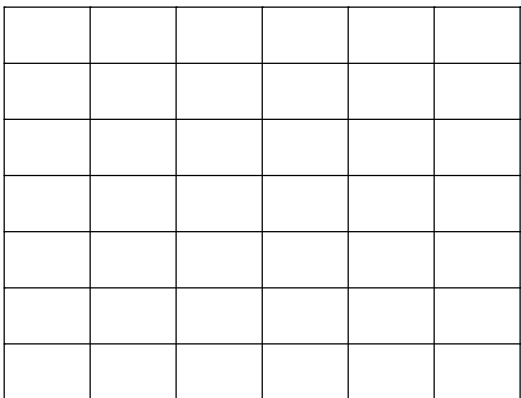
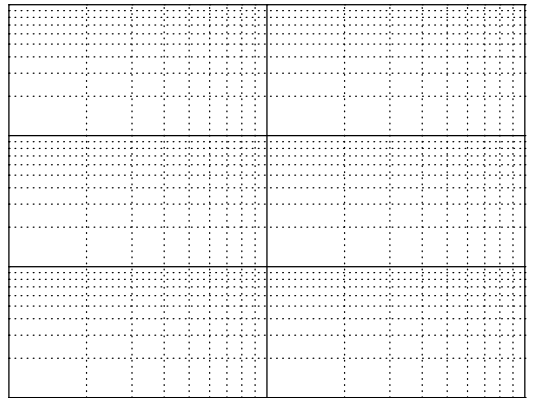
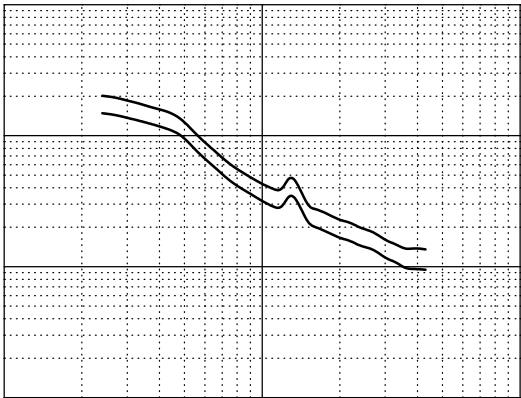
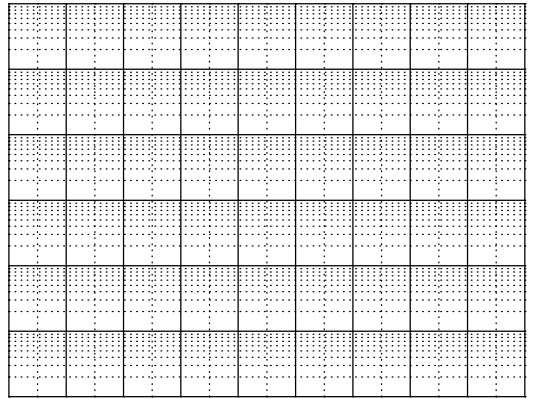
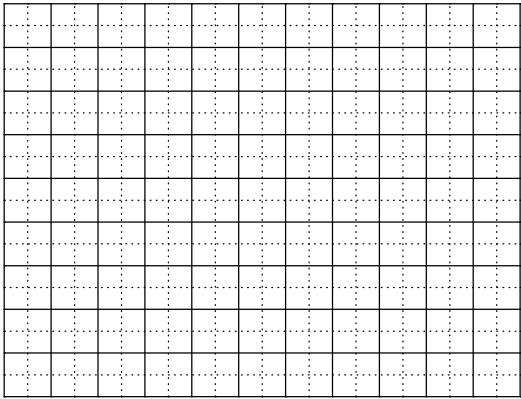
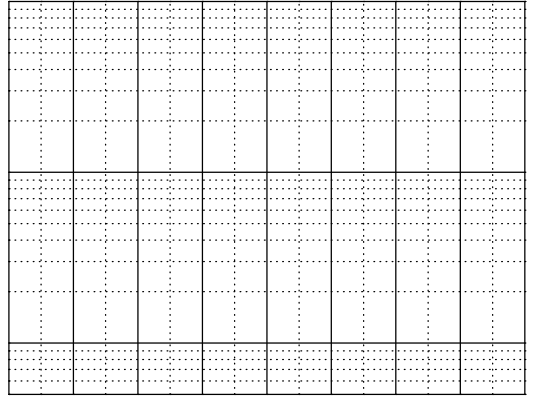
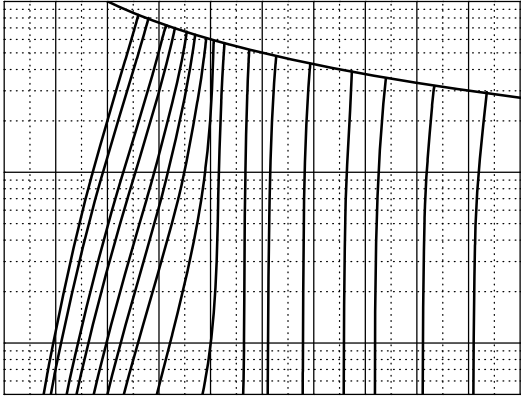

Note:

1. Controlling dimension: in millimeters.
2. General tolerance: $\pm 0.05\text{mm}$.
3. The pad layout is for reference purposes only.

NOTICE

JCET reserve the right to make modifications, enhancements, improvements, corrections or other changes without further notice to any product herein. JCET does not assume any liability arising out of the appli -

SOT-23 Embossed Carrier Tape

Dimensions are in millimeter										
Pkg type	A	B	C	d	E	F	P0	P	P1	W
SOT-23	3.15	2.1								

SOT-23 Tape Leader and Trailer

SOT-23 Reel

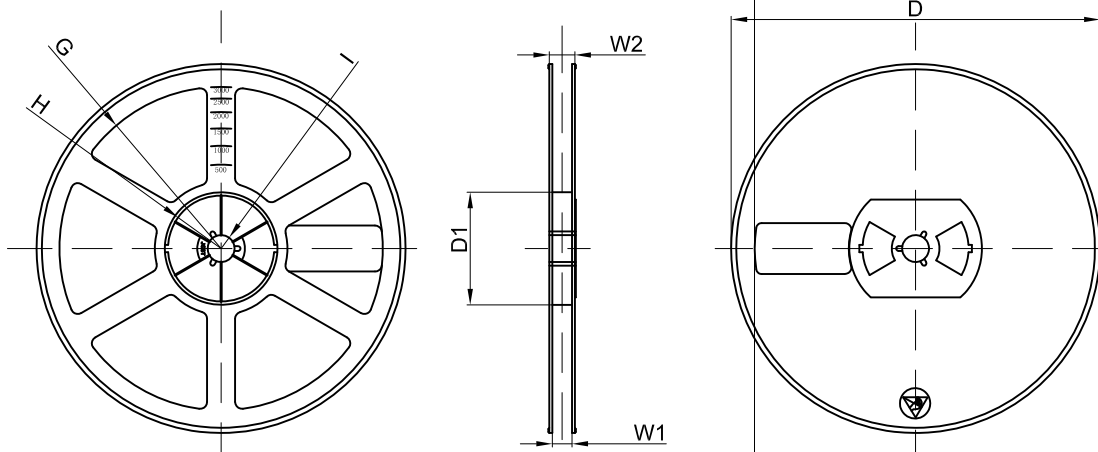

REEL	Reel Size	Box	Box Size(mm)	Carton	Carton Size(mm)	G.W.(kg)
3000 pcs	7 inch	45,000 pcs	203×203×195	180,000 pcs	438×438×220	